

# Molteni & C

## MARTEEN — VINCENT VAN DUYSSEN 2021

1—  
8



The Marteen is a multifunctional seating and storage system introducing harmony with perfectly balanced volumes, in an alternation of solids and voids.



This symbol shows that the product has removable upholstery. Only qualified personnel can remove the upholstery of some of our products. If this information is pertinent, it will be included in the warnings section.



This symbol shows that the product is available on request in a fire resistant version that complies with the standards BS 5852 and TB 117-2013. The buyer is responsible for checking to make sure that the product is suitable and compliant with the requirements for the designated use and the current applicable laws and standards for the destination and use of the product.

**DATASHEET**

REGISTERED  
DESIGN

IX.2022

**moltenigroup.com**

Dimensions in centimeters and inches. The right to discontinue and make changes is reserved. This information is based on the latest product information available at the time of printing

**FINISHES**

**BASE FINISHES**

painted pewter colour

**TECHNICAL INFORMATION**

**INTERNAL STRUCTURE**

Frame made of solid Firwood (Picea abies) and wood particle panels with elastic straps.

**STRUCTURE PADDING**

High performance variable density polyurethane foam. Cover in bonded velveteen.

**BACK CUSHIONS**

Solotex. 100% cotton cover.

**BASE**

Feet in painted hot-welded steel with non-slip plastic ferrules.

**REMOVABLE OUTER COVER**

(See enclosed sheet, specific for the cover in question).

**MODULES WITH DRAWER**

Top: Honeycombed panel covered with an Oak (Quercus) or Eucalyptus (Eucalyptus globulus) wood veneer;  
Drawer: Folded and matt lacquered medium-density fibre panel; structure reinforced with metal plates.

**SMALL TABLES WITH DRAWER**

Top: Honeycombed panel covered with an Oak (Quercus) or Eucalyptus (Eucalyptus globulus) wood veneer;  
Drawer: Folded and matt lacquered medium-density fibre panel; structure reinforced with metal plates.  
Base: Wood particle panel, matt lacquered.

**SMALL TABLES**

Top: Honeycombed panel covered with an Oak (Quercus) or Eucalyptus (Eucalyptus globulus) wood veneer;  
Base: Laminate-faced, matt lacquered honeycombed panel.



AVAILABLE IN FIRE-RESISTANT  
VERSION TB117 AND BS5852

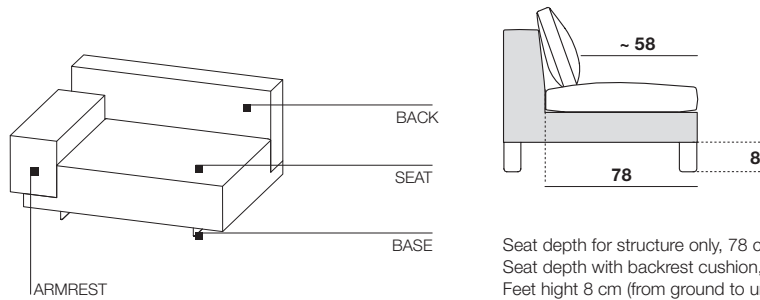

**MODULES WITH DRAWER**

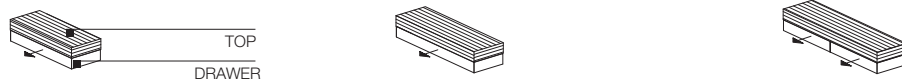

**SMALL TABLES WITH DRAWER**

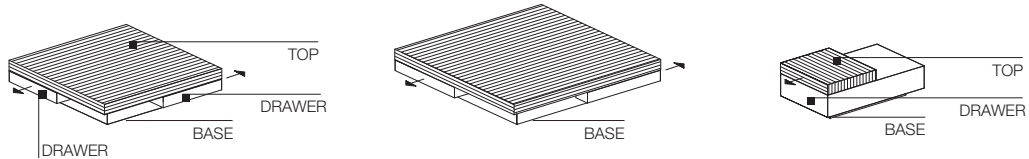

**SMALL TABLES**

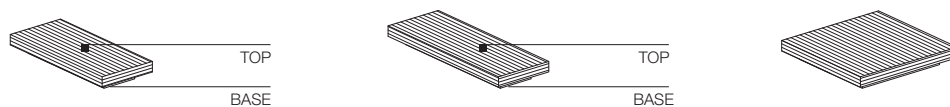

**DATASHEET**

REGISTERED  
DESIGN

IX.2022

## NOTES

For correct ergonomics and maximum comfort, it is advisable to design each module using one or more back cushions, according to the sizes proposed in the price list.  
In addition to correct ergonomics, the presence of these elements gives the product a complete and elegant appearance.

### When ordering

Specify the type and the number of backrests.

# Molteni & C

3—  
8

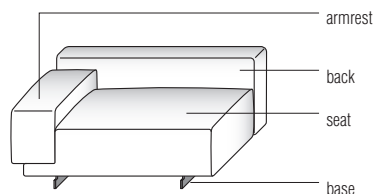

### Modules with drawer

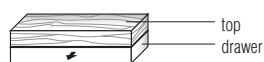

### Small tables

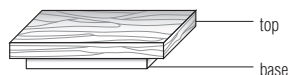

### Small tables with drawer

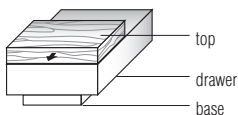
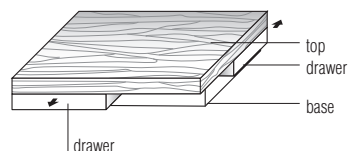

## DATASHEET

REGISTERED  
DESIGN

IX.2022

**DIMENSIONS**

Molteni & C

4—  
8

**end element with low armrest**

**TEB128 dx - sx**

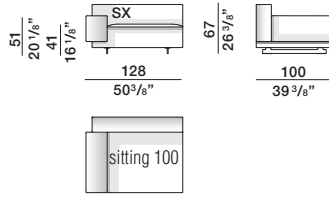

**end element with drawer**

**TEC128 dx - sx**

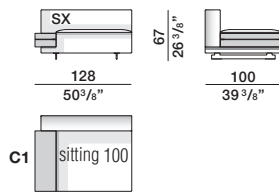

**corner end element**

**TEA120 dx - sx**

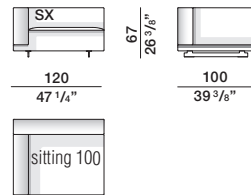

**end element with low armrest**

**TEB108 dx - sx**

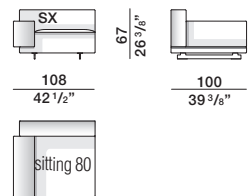

**end element with drawer**

**TEC108 dx - sx**

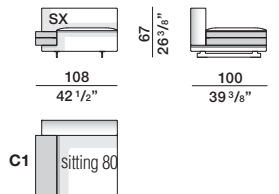

**corner end element**

**TEA100 dx - sx**

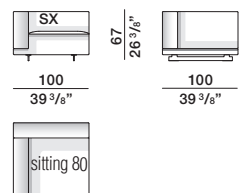

**back cushion**

**CS80/50**

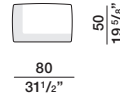

**back cushion**

**CS10/50**

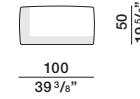

**back cushion**

**CS80/36**

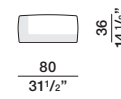

**back cushion**

**CS10/36**

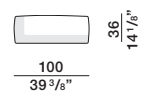

**back cushion**

**CS80/50**

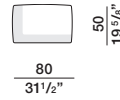

**back cushion**

**CS10/50**

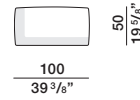

**back cushion**

**CS80/36**

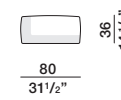

**back cushion**

**CS10/36**

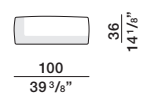

**back cushion**

**CS80/50**

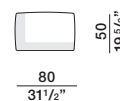

**back cushion**

**CS10/50**

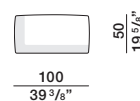

**back cushion**

**CS80/36**

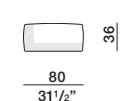

**back cushion**

**CS10/36**

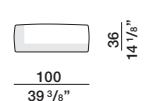

**back cushion**

**CS60/50**

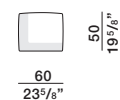

**back cushion**

**CS80/50**

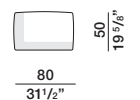

**back cushion**

**CS60/36**

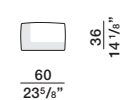

**back cushion**

**CS80/36**

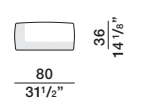

**back cushion**

**CS60/50**

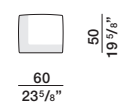

**back cushion**

**CS80/50**

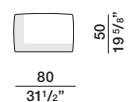

**back cushion**

**CS60/36**

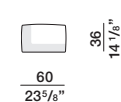

**back cushion**

**CS80/36**

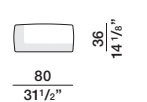

**back cushion**

**CS60/50**

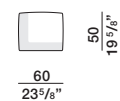

**back cushion**

**CS80/50**

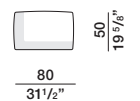

**back cushion**

**CS60/36**

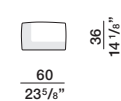

**back cushion**

**CS80/36**

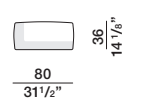

**DATASHEET**

REGISTERED  
DESIGN

IX.2022

**DIMENSIONS**

**central element**  
**CEN120**

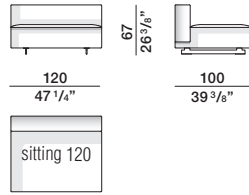

**seat with drawer**  
**CEC120**

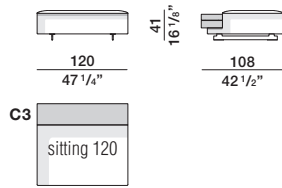

**central element**  
**CEN100**

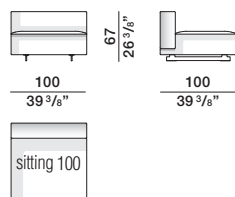

**seat with drawer**  
**CEC100**

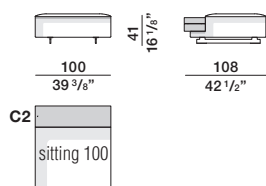

**central element**  
**CEN080**

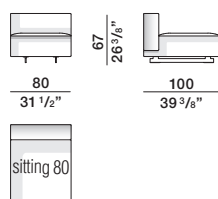

**seat with drawer**  
**CEC080**

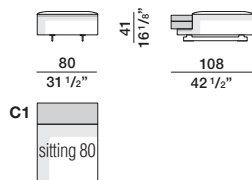

**back cushion**

**CS10/50**

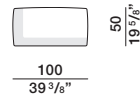

**back cushion**

**CS60/50**

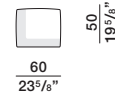

**back cushion**

**CS10/36**

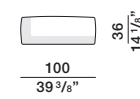

**back cushion**

**CS60/36**

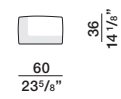

**back cushion**

**CS80/50**

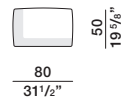

**back cushion**

**CS10/50**

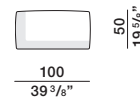

**back cushion**

**CS80/36**

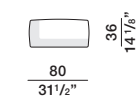

**back cushion**

**CS10/36**

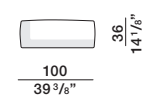

**back cushion**

**CS60/50**

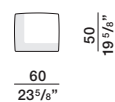

**back cushion**

**CS80/50**

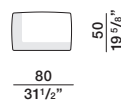

**back cushion**

**CS60/36**

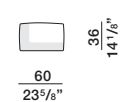

**back cushion**

**CS80/36**

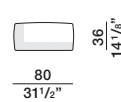

**DATASHEET**

REGISTERED  
DESIGN

IX.2022

**DIMENSIONS**

**low armrest island**

ISB128 dx - sx

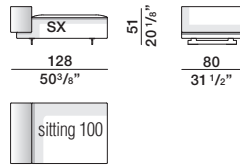

**island with drawer**

ISC128 dx - sx

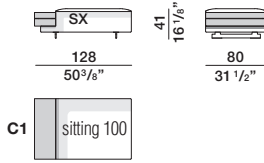

**low armrest island**

ISB108 dx - sx

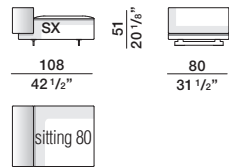

**island with drawer**

ISC108 dx - sx

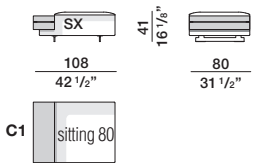

**chaise longue with low armrest**

CLB128 dx - sx

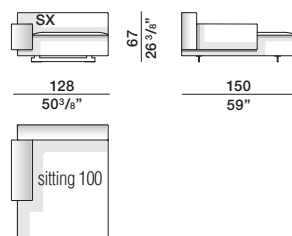

**chaise longue with drawer**

CLC128 dx - sx

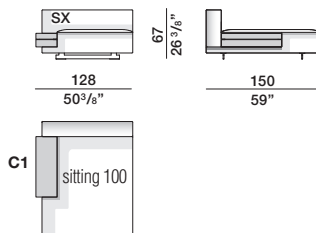

**back cushion**

CS80/50

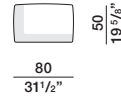

**back cushion**

CS10/50

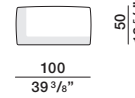

**back cushion**

CS80/36

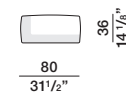

**back cushion**

CS10/36

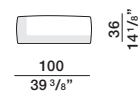

**back cushion**

CS80/50

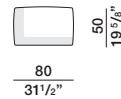

**back cushion**

CS10/50

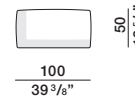

**back cushion**

CS80/36

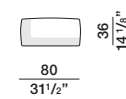

**back cushion**

CS10/36

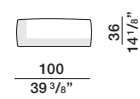

**back cushion**

CS60/50

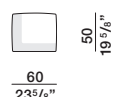

**back cushion**

CS80/50

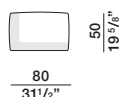

**back cushion**

CS60/36

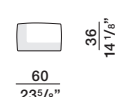

**back cushion**

CS80/36

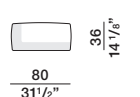

**back cushion**

CS60/50

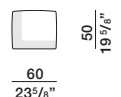

**back cushion**

CS80/50

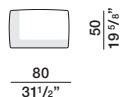

**back cushion**

CS60/36

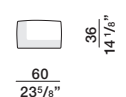

**back cushion**

CS80/36

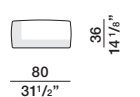

**back cushion**

CS80/50



**back cushion**

CS10/50



**back cushion**

CS80/36

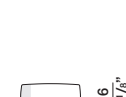

**back cushion**

CS10/36



**back cushion**

CS80/50



**back cushion**

CS10/50



**back cushion**

CS80/36



**back cushion**

CS10/36



**DATASHEET**

REGISTERED  
DESIGN

IX.2022

**DIMENSIONS**

**daybed**  
**DBE100**

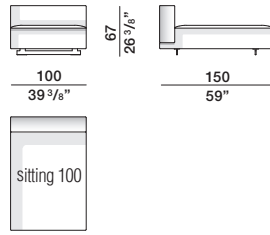

**back cushion**  
**CS80/50**

CS80/50

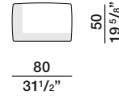

**back cushion**  
**CS10/50**

CS10/50

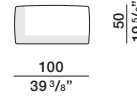

**back cushion**  
**CS80/36**

CS80/36

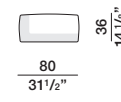

**back cushion**  
**CS10/36**

CS10/36

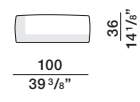

**pouf**  
**PF12/10**

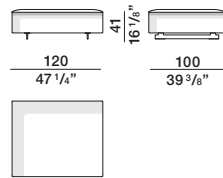

**pouf**  
**PF10/10**

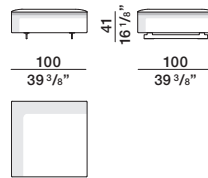

**pouf**  
**PF60/10**

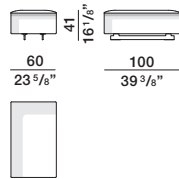

**pouf**  
**PF10/80**

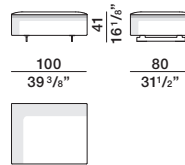

**pouf**  
**PF80/80**

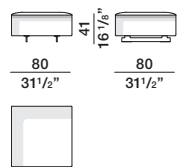

**ornamental cushion**  
**PCU90/75**

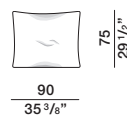

**ornamental cushion**  
**CF48**

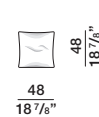

**DATASHEET**

REGISTERED  
DESIGN

IX.2022

**FINISHES**

DRAWERS  
AND BASE FINISH  
pewter colour lacquered

TOP FINISHES

eucalyptus  
thermo oak

**ATTENTION:**

► The modules with drawers (C1-C2-C3) can not ordered individually, but only in combination with the modules provided as per the price list

► No reductions of any kind are possible

Molteni&C

**DIMENSIONS**

**C1**  
module with 1 drawer

CAS1

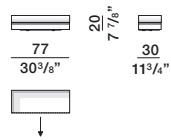

small table

TAV1

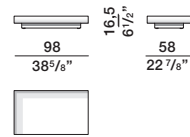

small table with 2 drawers

TAC2

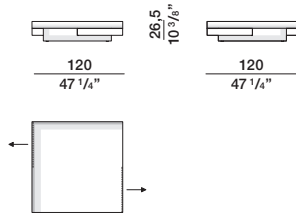

**C2**  
module with 1 drawer

CAS2

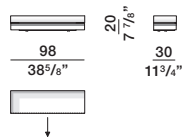

small table

TAV2

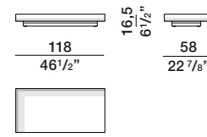

small table with 2 drawers

TAC3

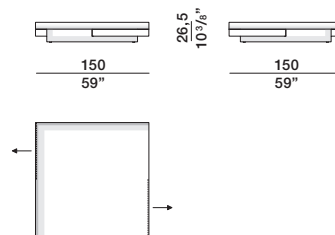

**C3**  
module with 2 drawers

CAS3

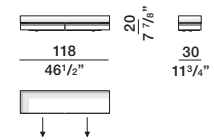

small table

TAV3

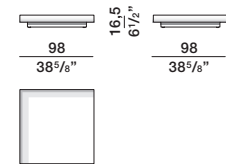

small table with 1 drawer

TAC1

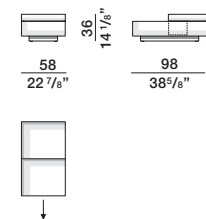

code	gross weight kg.	volume mc.	packages	code	gross weight kg.	volume mc.	packages
TEB128	69	1,1	1	CLC128	72	1,56	1
TEC128	59,5	1,05	1	DBE100	62	1,25	1
TEA120	67	1,025	1	PF12/10	40	0,63	1
TEB108	61,8	0,94	1	PF10/10	36,8	0,53	1
TEC108	53	0,88	1	PF60/10	29	0,34	1
TEA100	61	0,87	1	PF10/80	32	0,46	1
CEN120	62	1,07	1	PF80/80	29	0,37	1
CEC120	42,5	0,8	1	CAS1	21	0,073	1
CEN100	55	0,92	1	CAS2	23	0,16	1
CEC100	38,5	0,6	1	CAS3	37	0,27	1
CEN080	48	0,69	1	TAV1	23	0,16	1
CEC080	34	0,443	1	TAV2	27	0,18	1
ISB128	45	0,69	1	TAV3	37	0,27	1
ISC128	35	0,61	1	TAC1	36	0,3	1
ISB108	42	0,63	1	TAC2	0,72	77	3
ISC108	32	0,475	1	TAC3	0,9	95,5	3
CLB128	81	1,63	1				

**DATASHEET**

REGISTERED  
DESIGN

IX.2022