

PIANCA

**+14%**

dal / from 05.09.2022

# Progetti di design

## **05 - Cristina Celestino Federica Biasi**

CALATEA, PEONIA, NAAN

Price List 03<sup>rd</sup> October 2022

**PIANCA**



---

## TABLE OF CONTENTS

---

<b>Sofa</b>		
	Peonia	4
<b>Armchairs</b>		
	Calatea	8
	Naan	9
<b>Dimensions, weights, fabrics and leathers</b>		10

## PEONIA by Cristina Celestino | Characteristics

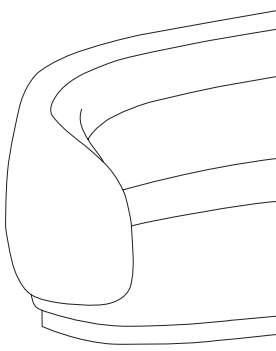

- The **structure** is composed of a seat surface to which the double curved backrest is attached, and is made with
- plywood panels
  - differentiated-density polyurethane foam padding
  - internal fibre-lined velvet lining
  - external cover upholstered to the structure and therefore non-removable
- The **seat surface**, sprung with elastic straps, supports the **seat cushion** made with
- differentiated-density polyurethane foam padding
  - internal fibre-lined velvet lining
  - removable outer cover with zip
- The removable **lower back cushion** is made with
- polyurethane padding
  - internal fibre-lined velvet lining
  - removable outer cover with zip

The sofas are shipped as one package and the backrest can be removed if necessary.

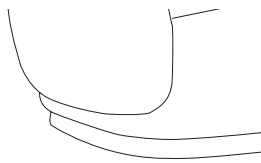

### Plinth

- 5 cm H
  - made with particle board panels with Nero Opaco edge or covered with the same fabric as the sofa.
- The armchair with swivel base features an internal rotating mechanism with 90° return.  
1 cm high feet in black ABS are fitted under the plinth.



### Cover

- in non-removable fabric, leather or faux leather for the structure and the plinth
- in removable fabric, leather or faux leather for the seat and lower back cushions
- the leather sofa includes additional seams

### Stitching

- taut and smooth
- with single and double stitched seams

### Limitations

- cannot be upholstered in Byte and Supersuede fabric

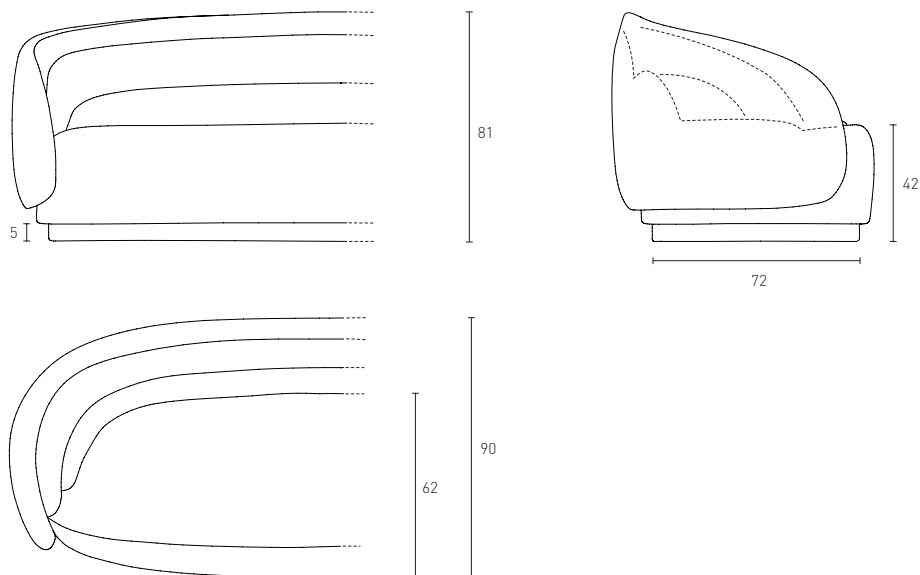

When placing your order, we recommend referring to the characteristics of the fabrics and leathers in the "Dimensions, weights, fabrics and leathers" section.

### Diagram

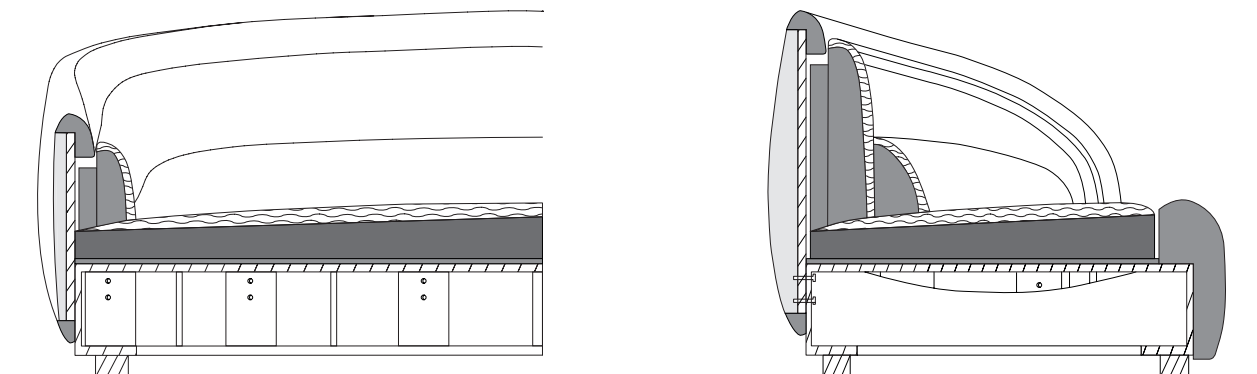

Internal construction



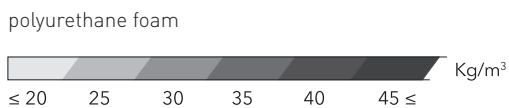

-  viscoelastic
-  plywood panels



On request and with a surcharge, the Peonia model can be manufactured with a fire-repellent internal structure. To calculate the price, please refer to the "Fire-repellent structure" section of the Day Collection price list.

Modularity planner

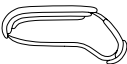
	W 100	W 200	W 230	
armchairs and sofas				
sofas with peninsula				W 290 



Armchair W 100

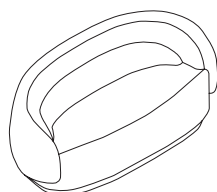



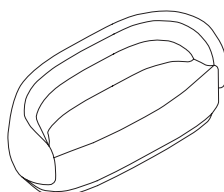

Sofa W 200

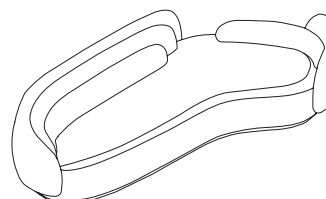

Sofa W 230

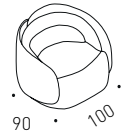

Sofa with peninsula W 290

Plinth Nero Opaco Covered with fabric		W	H	D	CODES	A C.O.M.	B	C	H	D	Q
<b>Throw cushions</b>											
		45	45		<b>99PE745</b>	87	94	104	130	156	216
	cover				<b>F9PE745</b>	39	47	57	83	109	169
		60	35		<b>99PE735</b>	87	94	104	130	156	216
	cover				<b>F9PE735</b>	39	47	57	83	109	169
		60	60		<b>99PE760</b>	123	134	148	185	222	307
	cover				<b>F9PE760</b>	56	67	81	117	155	240
<b>Armchair with a fixed base</b>											
	<b>with Nero Opaco plinth</b>	100	81	90	<b>D9PE011</b>	2.175	2.285	2.394	2.828	3.307	4.133
	cover for throw cushions				<b>F9PE001</b>	891	1.001	1.110	1.544	2.023	2.849
	<b>with upholstered plinth</b>	100	81	90	<b>D9PE010</b>	2.175	2.285	2.394	2.828	3.307	4.133
	cover for throw cushions				<b>F9PE000</b>	891	1.001	1.110	1.544	2.023	2.849
		90	100								
<b>Armchair with a swivel base</b>											
	<b>with Nero Opaco plinth</b>	100	81	90	<b>D9PE001</b>	2.423	2.545	2.666	3.150	3.683	4.604
	cover for throw cushions				<b>F9PE001</b>	891	1.001	1.110	1.544	2.023	2.849
	<b>with upholstered plinth</b>	100	81	90	<b>D9PE000</b>	2.423	2.545	2.666	3.150	3.683	4.604
	cover for throw cushions				<b>F9PE000</b>	891	1.001	1.110	1.544	2.023	2.849
		90	100								

**Plinth**  
Nero Opaco  
Covered with fabric

**Sofas**



**with Nero Opaco plinth**

cover for throw cushions

cover for throw cushions

**with upholstered plinth**

cover for throw cushions

cover for throw cushions

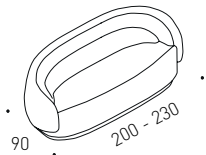

**Sofas with peninsula**

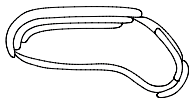

**with Nero Opaco plinth**

cover for throw cushions

**with upholstered plinth**

cover for throw cushions

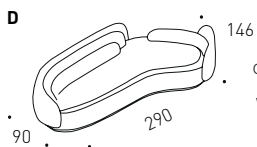

	W	H	D	CODES	A C.O.M.	B	C	H	D	Q
	200	81	90	<b>D9PE201</b>	3.106	3.262	3.418	4.038	4.722	5.902
				<b>F9PE201</b>	1.274	1.429	1.585	2.206	2.889	4.069
	230	81	90	<b>D9PE231</b>	3.417	3.588	3.759	4.442	5.194	6.492
				<b>F9PE231</b>	1.400	1.571	1.742	2.425	3.177	4.475
	200	81	90	<b>D9PE200</b>	3.106	3.262	3.418	4.038	4.722	5.902
				<b>F9PE200</b>	1.274	1.429	1.585	2.206	2.889	4.069
	230	81	90	<b>D9PE230</b>	3.417	3.588	3.759	4.442	5.194	6.492
				<b>F9PE230</b>	1.400	1.571	1.742	2.425	3.177	4.475
	290	81	146	<b>D9PE291 D/S</b>	4.349	4.567	4.784	5.654	6.611	8.263
				<b>F9PE291 D/S</b>	1.782	2.001	2.218	3.087	4.044	5.696
	290	81	146	<b>D9PE290 D/S</b>	4.349	4.567	4.784	5.654	6.611	8.263
				<b>F9PE290 D/S</b>	1.782	2.001	2.218	3.087	4.044	5.696



The images in the price list show products with right-hand configuration (D). The left-hand configurations (S) are to be intended as symmetrical.

# CALATEA by Cristina Celestino | Armchair and ottoman

- Characteristics** The **structure** is made from covered rigid polyurethane.  
The **seat and backrest cushions** are made from differentiated-density polyurethane foam padding with lining in fibre-lined velvet.
- Cover** · in removable fabric, except for the rigid structure's upholstery which is always glued on  
· in non-removable Leather or Synthetic leather
- Limitations** The **rigid structure** can **only** be upholstered  
· in Acacia, Aries, Aquarius, Bellis, Dalia, Erica, Fenice, Hermes, Jazz, Kos, Lima, Narciso, Malva, Mimosa, Rico, Supersuede, Velvet and Zea fabric  
· in Lord, Nabuk and Polo Leather  
The **backrest cushion** can also be upholstered in Calatea fabric (category H) in an exclusive print inspired by the leaf of the South American plant of the same name, the Calatea.  
When placing your order, we recommend referring to the characteristics of the fabrics and leathers in the "Dimensions, weights, fabrics and leathers" section.

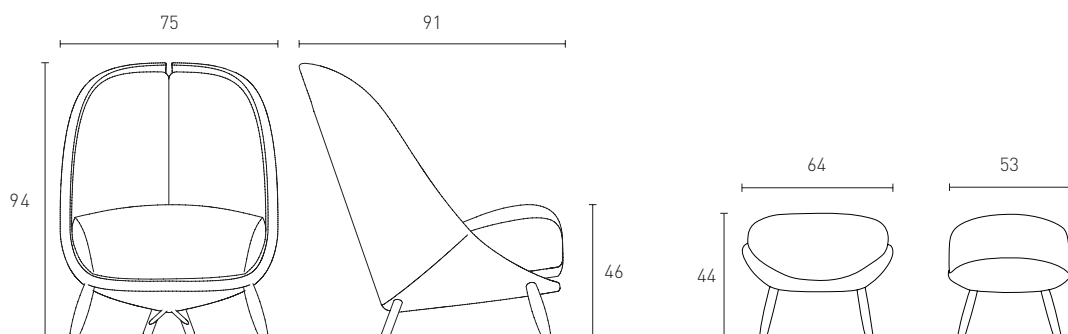
**If different categories are used for the upholstery of the armchair, the price will be in the higher category.**



	W	H	D	CODES	A C.O.M.	B	C	H Calatea fabric	D	Q
<b>Standard legs</b> Wood Laccato Opaco Laccato Lucido Nero										
<b>Armchair</b> Fabrics recommended for the armchair fabric backrest with the exclusive Calatea print rigid backrest in Erica fabric col. 61 seat in Rico fabric col. 31										
 seat and backrest upholstery	<b>75</b>	<b>94</b>	<b>91</b>	<b>D9CA010</b> <b>F9CA010</b>	1.644 673	1.776 805	1.891 920	2.270 1.298	2.713 -	3.124 -
<b>Ottoman</b> Fabrics recommended for matching the armchair with exclusive print rigid structure in Erica fabric col. 61 seat in Rico fabric col. 31										
 seat upholstery	<b>64</b>	<b>44</b>	<b>53</b>	<b>D9CA070</b> <b>F9CA070</b>	612 251	661 300	704 343	844 483	1.009 -	1.163 -



# NAAN by Federica Biasi | Armchair

## Characteristics

Available with either a fixed or swivel base.

The **structure** is

- cold moulded, in flexible polyurethane with steel reinforcement
- internal fibre-lined velvet lining

The **seat cushion**, sprung with elastic straps, is made with

- plywood panels
- polyurethane foam padding
- internal fibre-lined velvet lining

The **plinth** is made from particle board coated with Laccato Opaco Nero. The version with swivel base features an internal rotating mechanism with 90° return.

## Cover

- armchair in removable fabric
- armchair in non-removable Leather or Synthetic leather
- seat cushion in removable fabric

## Tailoring

- taut and smooth
- with single and double stitched seams

## Limitations

There are no limitations as to the use of fabrics

When placing the order, we recommend that you refer to the characteristics of fabrics and leathers in the "Dimensions, weights, fabrics and leathers" section.

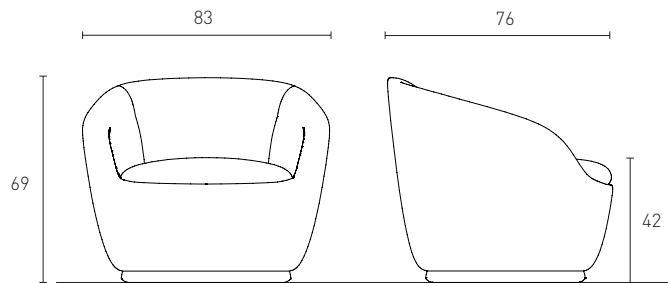

Plinth Laccato Opaco Nero	W	H	D	CODES	A	B	C	H	D	Q
					C.O.M.					
<b>With a fixed base</b>										
	83	69	76	D9NA010 F9NA000	1.326	1.432	1.525	1.791	1.989	2.320
					cover	543	649	743	1.008	1.206
<b>With swivel base</b>										
	83	69	76	D9NA000 F9NA000	1.575	1.701	1.812	2.126	2.362	2.756
					cover	543	649	743	1.008	1.206

## DIMENSIONS, WEIGHTS, FABRICS AND LEATHERS

CALATEA	Mc	Kg	ML	NAAN	Mc	Kg	ML	PEONIA	Mc	Kg	ML
<b>MODULES</b>				<b>MODULES</b>				<b>MODULES</b>			
D9CA010	0,7	43	2,3	D9NA000	0,49	50	3,2	99PE735	0,02	3	0,8
D9CA070	0,38	25	3,3	D9NA010	0,49	50	3,2	99PE745	0,02	3	0,8
								99PE760	0,02	3	1
								D9PE000	0,8	50	5,3
								D9PE001	0,8	50	5,3
								D9PE010	0,8	50	5,3
								D9PE011	0,8	50	5,3
								D9PE200	1,59	95	8,5
								D9PE201	1,59	95	8,5
								D9PE230	1,83	100	10
								D9PE231	1,83	100	10
								D9PE290 D/S	3,75	120	12
								D9PE291 D/S	3,75	120	12

The information above refers only to modules/sofas made with 140 cm high fabric, with no pattern repeat and no direction of weave.



**PIANCA**

Via dei Cappellari, 20  
31018 – Gaiarine, Treviso  
ITALY

T +39 0434 756911  
F +39 0434 75330

info@pianca.com  
pianca.com

p.iva IT 01682580269

Vietata la riproduzione a qualsiasi scopo.  
Campione promozionale gratuito non destinato alla vendita.  
Escluso iva art.2 comma 3 D.P.R. 633/72 - esonerato da  
documento di trasporto art.4 punto 6 D.P.R. 627/78



N.B22LLT2T